

HIKERS

User Manual

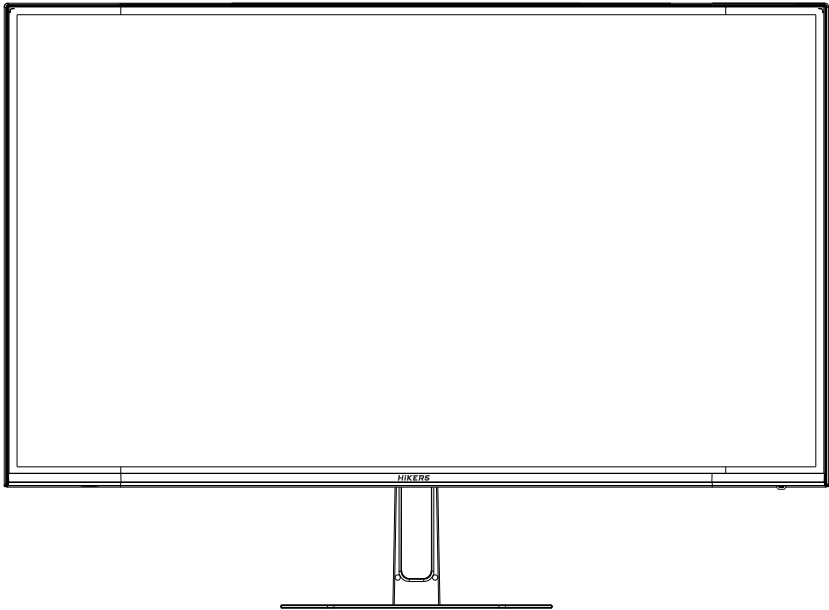

QHD Gaming Monitor G27H1Q Pro

Before using this machine, please read the manual carefully and keep it for future reference. Color and appearance may vary depending on the specific model of the product. Specifications are subject to future changes to improve performance without notice.

Table Of Contents

Warning! Important Safety Instructions.....	1
Accessories.....	3
Installation of the base.....	3
Adjust The Angle.....	3
Cable connection.....	4
Panel control.....	4
Using The OSD Menu.....	5
Other.....	7
Help.....	8

Warning! Important Safety Instructions

Please read the below warnings carefully before you install and use our product.

CAUTION: DO NOT REMOVE COVER TO REDUCE RISK OF ELECTRIC SHOCK.

There are no user serviceable parts inside. Be sure to have repairs performed by qualified service personnel.



 This symbol means that dangerously high voltage is present inside. Any form of contact with any part inside the product is dangerous.

 This symbol reminds you of the important instructions that come with the operation and maintenance of this product.

- Slots and holes in the chassis and at the rear and bottom are designed to provide necessary ventilation. Do not block or cover these slots and holes in order to ensure the operability of this machine and to prevent it from overheating. Do not cover slots and holes with cloth or other materials.
- Do not place the machine on beds, sofas, carpets or other similar surfaces to avoid clogging of said slots and holes. Do not place this machine in restricted spaces (eg bookcases or built-in cupboards) unless proper ventilation is provided. A gap of 10 cm should be maintained between the product and the wall.
- Do not place this machine near or over electric heaters or radiators, or in places exposed to direct sunlight.
- Do not place heat-generating objects (such as candles, ashtrays, incense, flammable gas or explosive substances, etc.) near the product.
- Do not place containers filled with water on this machine as this may result in a fire or electric shock hazard.
- Do not expose the product to oily substances or chemical agents, as this may cause corrosion of the product casing.
- Do not expose this machine to rain or near water (e.g. near a bathtub, sink, kitchen sink, or laundry sink, in a wet basement, or near a swimming pool).
If the machine gets wet accidentally, please unplug the power cord or power adapter immediately, and then promptly contact an authorized dealer for further assistance. When cleaning the monitor, be sure to use a dry, soft cloth that does not contain volatile substances. Before cleaning, be sure to unplug the power cord or power adapter.
- Do not overload wall outlets, extension cords, or integral convenience receptacles as this may result in fire or electric shock.
- The power cord or power adapter should be placed in a location where it will not be stepped on or squeezed by objects above or next to it, and special attention should be paid to the wires at the plug, at the integral convenience receptacles and at the outlet of the machine.
- To better protect this machine in lightning weather or when it is left unattended or unused for a long time, please unplug its power cord or power adapter, and disconnect the antenna or cable system.
This prevents damage to the machine during a lightning storm or in the event of a power surge on the power line.
- Before connecting the AC power cord to the power adapter or monitor power interface (subject to the actual product style), please make sure that your local power supply meets the requirements of power adapter or monitor input voltage.
- Be sure not to insert any metal objects into the holes of this machine, otherwise it may cause a danger of electric shock.
- Do not touch the inside of this machine to prevent electric shock. Only qualified technicians are allowed to open the cover of this machine.
- Make sure that the power cord plug or power adapter can be securely inserted into the outlet. When disconnecting the power cord, make sure to firmly grasp the power plug or power adapter and unplug it from the outlet.
- Do not touch the power cord or power adapter with wet hands.
- If the machine does not operate normally, especially if it emits any unusual sound or smell, unplug the power outlet immediately and contact an authorized dealer or service center for further assistance.

Warning! Important Safety Instructions

- If you plan to leave the monitor unused for an extended period of time, or if you are going to be away from home (especially if there are children, the elderly, or people with disabilities left alone), be sure to unplug the power plug or power adapter from the outlet.
Accumulated dust may cause sparks and heat from the power cord or power adapter or cause the insulation of the power cord or power adapter to deteriorate, resulting in electric shock, leakage or fire.
- After the monitor is moved from a low temperature place to a warm area, it should be placed for a period of time before powering on, so that the condensation inside the monitor can be fully dissipated and dried.
- The power supply voltage will be marked on the back of the monitor, DC 12V.
- If you plan to install this product in dusty, high or low temperature, high humidity, chemical-containing environments and 24-hour use locations (such as airports or train stations, etc.), be sure to contact an authorized service center for further assistance. Otherwise, the monitor may be severely damaged.
- Be sure to use only properly grounded plugs and sockets. Poor grounding may result in electric shock or equipment damage. (for Class I equipment only)
- To disconnect the power from the device, the power cord or power adapter plug must be unplugged from the machine, so the power cord or adapter plug should be easily accessible.
- Children are prohibited from climbing on this product.
- Keep the accessory parts out of the reach of children.
- Do not install this product in an unstable location, such as a wobbly shelf, sloping floor, or a location subject to external vibration.
- Do not drop the product or subject it to shock. If the product is damaged, please disconnect the power supply and contact the service center in time for further assistance.

IC Statement:

This device complies with Industry Canada licence-exempt RSS standard(s). Operation is subject to the following two conditions: (1) this device may not cause interference, and (2) this device must accept any interference, including interference that may cause undesired operation of the device.

WARNING:

Changes or modifications not expressly approved by the party responsible for compliance could void the user's authority to operate the equipment.

Technical Specifications:

Operating temperature: -10°C ~ 35°C



Federal Communications Commission Declaration of Conformity

This device complies with Part 15 of the FCC Rules. Operation is subject to the following two conditions:

- (1) this device may not cause harmful interference, and
- (2) this device must accept any interference received, including interference that may cause undesired operation.

The following local Manufacturer/Importer is responsible for this declaration:

Product:	QHD Gaming Monitor
Model Number:	G27H1Q Pro
SKU Number:	G27H1Q Pro
Name of Responsible Party:	RAYING (HK) TECHNOLOGY LIMITED
Address of Responsible Party:	503A 5/F, Won Hing Building, 74-78 Stanley Street, Central HK

- a: The ventilation should not be impeded by covering the ventilation openings with items, such as newspapers, table-cloths, curtains, etc. This device is not intended to be used on soft support surfaces such as bedding, blankets, etc.
- b: The mains plug / adapter is used as the disconnect device, and the disconnect device shall remain readily operable.

Accessories

1. Please check if all items are included in your monitor set, if there are missing items; please contact your dealer in time.
2. Item color and shape may vary by model.
3. The cables provided may vary depending on the product purchased.

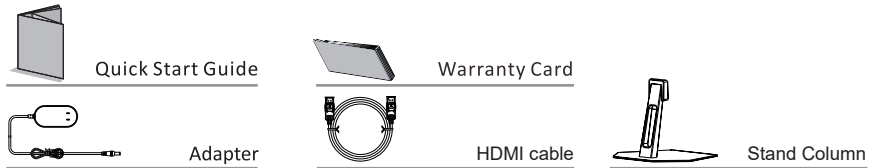

*Picture for reference purpose only.

Installation of the base

(*The functions of the monitor may vary depending on the model, the actual product shall prevail)

(Note: Use a screw driver to tighten the screw)

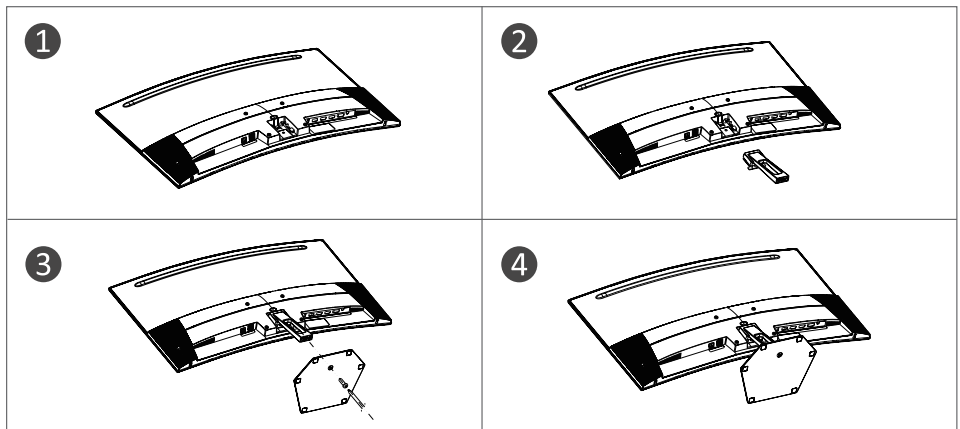

Adjust The Angle

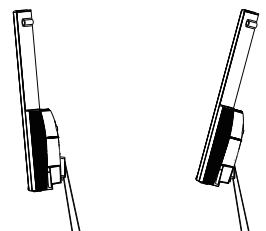

1. Drawings are for reference only and please refer to the actual monitor.
2. The angle of the screen can be adjusted forward 5° backward 15° for a comfortable angle.
3. Be careful not to touch or press the screen area when adjusting the angle of the monitor.



Cable connection





The configuration information on the back of the monitor varies by product model. Read the following contents before connecting the product.

1. Before connecting the product, be sure to check the two ports of the supplied signal cable, as well as the shape and position of the ports on the product and external devices.
2. Before connecting the product, be sure to remove the power cord or power adapter from the product and external devices to prevent damage to the product due to short circuits or overcurrent.
3. After all signal cables are properly connected, connect the power cord or power adapter back to the product and external devices.
4. After completed the connection, be sure to read the manual to familiarize yourself with the product features, precautions, and other information needed to use the product properly.

 <p>HDMI</p>	<p>HDMI: Using a HDMI cable to connect the product's HDMI port to the PC's HDMI OUT port.</p>	 <p>EARPHONE</p>	<p>EARPHONE OUT: Use a headset plug to connect to the EARPHONE OUT jack.</p>
 <p>DP</p>	<p>DP : Please link DP cable of LED to the port named DP IN at the back of the LED Monitor.</p>	<p>DC IN</p>	<p>DC IN 12V: Use the adapter to access the port, the power supply of this interface only supports DC 12V, use the matching adapter to access, please consult the authorized service center for the non-original adapter.</p>

Panel control

(5-way Joystick Key Definition)

1		Up: Input Select/up
2		Down: AI Cross Hair/Down
3		Left: Exit/Decrease/Return
4		Right: Game Mode/Increase/Next
5		Center: Menu/Confirm

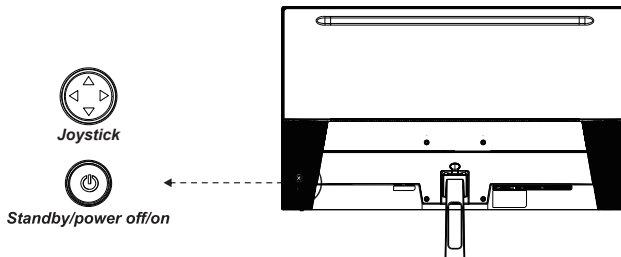

Using The OSD Menu

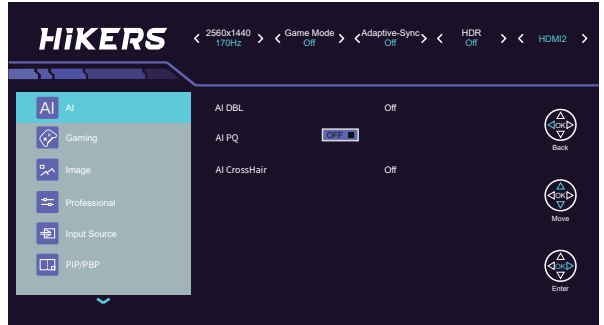
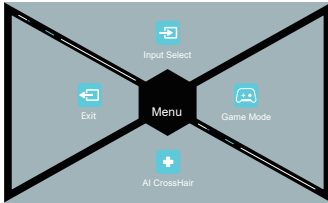

- 1.To view the OSD menu, press the center button down to enter the OSD menu.
- 2.Press the up/down keys to move the configuration options, press the center key down to confirm, adjust them with the left and right keys.
- 3.To return to the previous menu and select a menu item, press the button to the left.
- 4.To exit the OSD menu, press the button to the left until you exit.

Main Menu	Sub-Menu	Options	Description	
AI	AI DBL	Off/AI/Weak/Middle/Strong	AI dynamically adjusts Blue Light	
	AI PQ	On/Off	AI dynamically adjusts Picture Quality	
	AI CrossHair	Off/AI/Location/+/x/+/x/+/Reset	AI dynamically changes Crosshair Color according to the background	
Gaming	Game Mode	Off/Gamer/FPS/RTS/RPG	Select Game Mode	
	Adaptive-Sync	On/Off	Eliminate screen tearing and stuttering	
	Over Driver	Off/Normal/Fast/Dynamic/Extreme	Select Over Drive level for faster response time	
	Night Vision	Off/Full Screen/Window	Shadow booster to brighten dark areas	
	Refresh Rate	Off/Upper Left/Lower Left/Upper Right/Lower Right	Display the real-time frame rate at a specified position on the screen	
	Timer	Off/15:00/30:00/45:00/60:00	Timer for gaming	
Image	Brightness	0-100	Adjust display Brightness	
	Contrast	0-100	Adjust display Contrast	
	Black Equalize	0-100	Balance the brightness and darkness	
	Sharpness	0-4	Adjust Sharpness	
	Screen Size	Auto/16:9/4:3	Set aspect ratio	
	DCR	On/Off	Enable Dynamic Contrast Ratio	
	Saturation	0-100	Adjust Saturation	
	Hue	0-100	Adjust Hue	
	Color Temperature	User	6500K/7500K/9300K	Set color temperature
				Red 0-100
			Green 0-100	
		Blue 0-100		

Using The OSD Menu

Main Menu	Sub-Menu	Options	Description
Professional	Picture Mode	Standard/Movie/Office/Read Text/Energy Star/sRGB/DCI-P3	Select Picture Mode
	HDR	Auto/Off	Turn HDR function auto/off
	MPRT	On/Off	Reduce motion blur
	Gamma	1.8/2.0/2.2/2.4	Select Gamma value
Input Source	Auto	On/Off	Automatically select the input signal
	Input Select	HDMI1/HDMI2/DP	Select the input signal
PIP/PBP	Off	/	Turn Picture In Picture/Picture By Picture off
	PIP	PIP Size: Small/Medium/Large	Set PIP window size
		Location: Upper Left/Upper Right/Lower Left/Lower Right/Center	Set PIP window position
		Source: HDMI1/HDMI2/DP	Select PIP input signal (dual HDMI's not support)
		Display Switch: /	Switch PIP window position
		Audio Switch: /	Switch PIP audio position
	PBP	Source: HDMI1/HDMI2/DP	Select PBP input signal (dual HDMI's not support)
		Display Switch: /	Switch PBP window position
		Audio Switch: /	Switch PBP audio position
Shortcut	Up	Exit/Brightness/Night Vision/AI Cross Hair/Timer/Volume/AI PQ/Input Select/PIP/PBP/Adaptive-Sync/Picture Mode/Game Mode/AI DBL	Set Up key shortcut
	Down	Exit/Brightness/Night Vision/AI Cross Hair/Timer/Volume/AI PQ/Input Select/PIP/PBP/Adaptive-Sync/Picture Mode/Game Mode/AI DBL	Set Down key shortcut
	Left	Exit/Brightness/Night Vision/AI Cross Hair/Timer/Volume/AI PQ/Input Select/PIP/PBP/Adaptive-Sync/Picture Mode/Game Mode/AI DBL	Set Left key shortcut
	Right	Exit/Brightness/Night Vision/AI Cross Hair/Timer/Volume/AI PQ/Input Select/PIP/PBP/Adaptive-Sync/Picture Mode/Game Mode/AI DBL	Set Right key shortcut
OSD Setting	Laguage	English/Türkçe/Español/تغییر عملیة/Magyar/Italian/Français/한국인 / 简体中文 / German/Polski/Spellagen/Portuguese/Українська/ 日本語 /русский язык	Set OSD language
	Volume	0-100	Adjust headphone volume
	Mute	On/Off	Headphone mute
	Transparency	0-4	Adjust the OSD transprence value
	OSD Timeout	5-60	Set the screen OSD display duration
	H.Position	0-100	Adjust the horizontal position
	V.Position	0-100	Adjust the vertical position
	DDC/CI	On/Off	Enable DDC/CI for software control of the monitor
	Over Clock	On/Off	Enable overclocking for the maximum refresh rate
	Dual-mode	2560x1440/1280x720	Select Resolution mode
Reset	/	Reset monitor configurations	

*Please subject to the actual status of the menu.

Other

Plug and Play features:

This monitor can be installed on any compatible Plug and Play system.

The interaction between the monitor and the computer system provides optimal operating conditions and monitor settings.

In most cases, the monitor installation will be automatic unless the user chooses another setting.

Acceptable dead pixels:

The display of this product is made using an advanced semiconductor process with an accuracy of over 1 ppm (parts per million).

But some pixels may be too bright or black when displaying red, green, blue or white, this is not bad quality, please feel relieved to use!

This equipment is Class B IT equipment.

As the angle of the user looking at the screen changes, LED light may be seen on the edge of the product's frame, but this phenomenon is not harmful to the human body and does not affect the product's characteristics and performance.

WARNING

Never place a monitor set in an unstable location. A monitor set may fall, causing serious personal injury or death. Many injuries, particularly to children, can be avoided by taking simple precautions such as:

1. Using cabinets or stands recommended by the manufacturer of the monitor set.
2. Only using furniture that can safely support the monitor set.
3. Ensuring the monitor set is not overhanging the edge of the supporting furniture.
4. Not placing the monitor set on tall furniture (for example, cupboards or bookcases), without anchoring both the furniture and the monitor set to a suitable support.
5. Not placing the monitor set on cloth or other materials that may be located between the monitor set and supporting furniture,
6. Educating children about the dangers of climbing on furniture to reach the monitor set or its controls.

If your existing monitor set is being retained and relocated, the same considerations as above should be applied.

Note: don't hang at an angle to avoid the risk of falling off.

Note: When using a wall mounting support, the installation height cannot exceed 2m.

WARNING

Ne placez jamais un moniteur dans un endroit instable. Un moniteur peut tomber, causant des blessures graves ou la mort. De nombreuses blessures, en particulier chez les enfants, peuvent être évitées en prenant des précautions simples telles que:

1. Utilisation d'armoires ou de supports recommandés par le fabricant du moniteur.
2. Seulement en utilisant des meubles qui peuvent soutenir en toute sécurité l'ensemble de moniteur.
3. S'assurer que l'ensemble du moniteur ne surplombe pas le bord des meubles de support.
4. Ne pas placer le moniteur sur des meubles de grande taille (par exemple, des armoires ou des bibliothèques), sans ancrage à la fois les meubles et le moniteur mis à un support approprié.
5. Ne pas placer l'ensemble de l'écran sur des tissus ou d'autres matériaux qui peuvent être situés entre le jeu de l'écran et les meubles de support.
6. Eduquer les enfants sur les dangers de grimper sur des meubles pour atteindre le poste de contrôle ou ses commandes.

Si votre ensemble de moniteur existant est conservé et déplacé, les mêmes considérations que ci-dessus devraient être appliquées.

Remarque: ne pas accrocher à un angle pour éviter le risque de chute.

Remarque: lors de l'utilisation d'un support de montage mural, la hauteur d'installation ne peut pas dépasser 2m.

Help

Black screen appears/Cannot turn on the product

1. Please check if the power adapter is connected correctly
2. Please check whether the power adapter is normally connected to the 100-240V AC socket
3. Please check whether the signal detection cable information is displayed on the screen, check the cable connection between the PC and this product
4. Please check whether the HDMI cable is used for connection, if you connect the HDMI cable after the PC is started, or disconnect and reconnect the HDMI cable while using the PC, the screen may not display an image because some graphics cards cannot output a signal, in this case, please restart the PC after connecting the HDMI cable.